

KNX Technical Reference Manual

ABB i-bus[®] KNX

KNX Sensors



1 Quick-Start-Guide

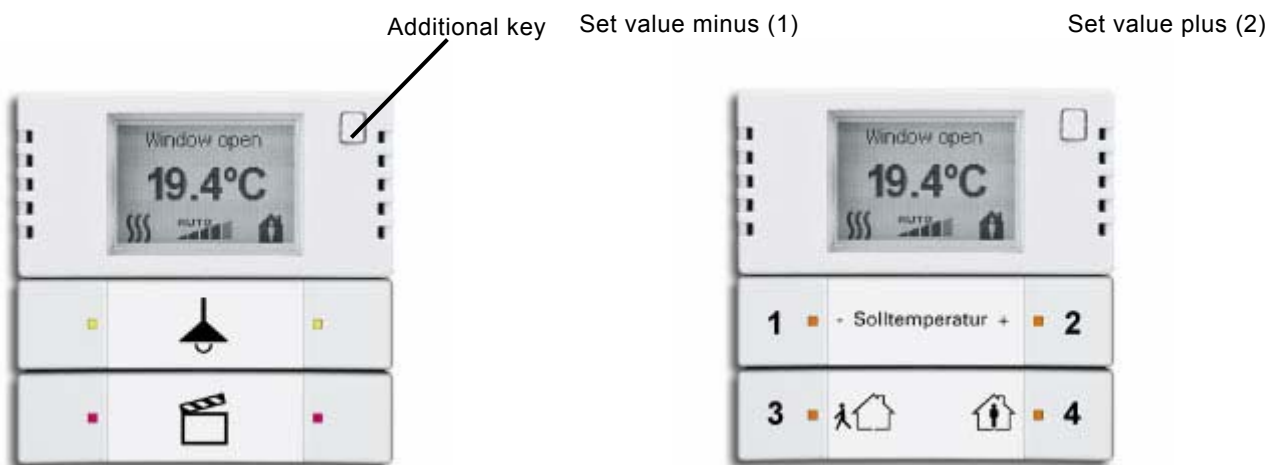

Operate sensor 6128/01-500 as a normal sensor with the freely programmable functions. To reach the setting level of the 6128/01-500 press the additional key once. The 6124/01-500 is located in this level from the start.

Operating mode - On/Off (3)

Fan level (4)

Use the top rocker switch (1/2) in the RTC setting level to adjust the set value. Use the bottom rocker switch (3/4) to adjust the operating modes. With a long press on the left button (3) the device is switched on and off. With the right right button you switch through the fan steps. By pressing the additional key in the RTC setting level view you reach the main menu

Menu

- Unit
- Contrast
- Language
- Jump-back time
- Text-change time
- Systeminfo
- Factory settings



Note

For a detailed description please read the chapter "Operating the room thermostat".

2 Safety instructions



Work on the 230 V power supply system must only be performed by specialist staff. Disconnect the mains power supply prior to mounting and/or disassembly! Failure to observe the installation and operating instructions may result in fire or other hazards.



Disclaimer

The content of this printed material has been checked for compliance with hardware and software. However, no liability can be assumed for any deviations that may still occur. Any necessary corrections will be implemented in future versions of this manual. Please advise us of any suggestions concerning the manual's improvement you may have.

3 Technical data

Attribute		Value
Power supply	KNX	24 V DC, via the bus
Protection		IP 20, according to DIN EN 60529
Ambient temperature range	Use	-5 °C to 45 °C
	Storage	-25 °C to 55 °C
	Transport	-25 °C to 70 °C
Licence		KNX certified
CE marking		According to EMC and low-voltage guideline

Note

A detailed parameter description can be found in the ETS plug-in software.

4 Connection

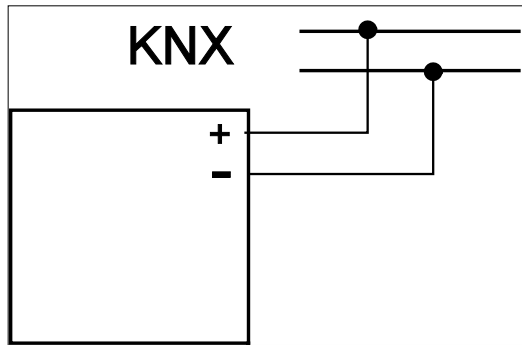

Connection to Twisted Pair

5 Dimensional drawings

Sensors

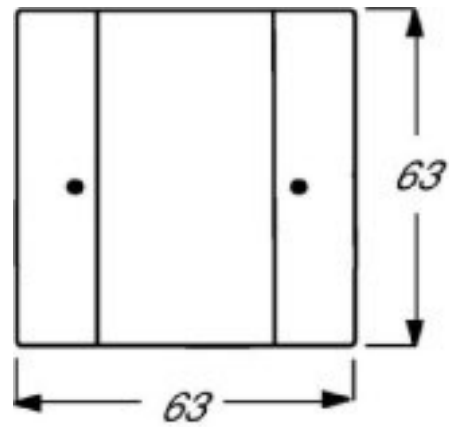

Dimensions

The sensors for installing in the frame that are listed in this manual have the same dimensions.

6 Overview of applications

Applications

KNX function	Control elements with bus coupler	Pushbutton coupler	Control elements for bus coupler (incl. 6128/01-500)	Busch-Watchdog®, flush-mounted	Room thermostat (6124/01-500), object range (6108/03-500)	Page
Switching, rocker total	•	•	•	-	-	See page 24
Switching rocker switch left/right	-	•	•	-	-	See page 24
Dimming rocker switch total	•	•	•	-	-	See page 24
Dimming rocker switch left/right	-	•	•	-	-	See page 25
Venetian blind switch rocker total	•	•	•	-	-	See page 25
Blind rocker switch left/right	-	•	•	-	-	See page 26
Short-long operation, rocker switch left/right	-	•	•	-	-	See page 26
Value sender rocker switch total	-	•	•	-	-	See page 27
Value sender rocker switch left/right	-	•	•	-	-	See page 27
LED functionality	•	•	•	-	-	See page 28
Setting RTC operation mode	-	•	•	-	-	See page 28
Value sender, 2 objects, rocker switch left/right	•	•	•	-	-	See page 29
Light scene extension unit with memory function	•	•	•	-	-	See page 29
Step-type switch rocker switch total	-	•	•	-	-	See page 30
Step-type switch rocker switch left/right	-	•	•	-	-	See page 30
Multiple operation	-	•	•	-	-	See page 31

Features

	Control elements with bus coupler	Pushbutton coupler	Control elements for bus coupler (incl. 6128/01-500)	Busch-Watchdog®, flush-mounted	Room thermostat (6124/01-500), object range (6108/03-500)
Temperature reading	-	-	•	-	•
RTC setting	-	-	•	-	•
Illuminated display	-	-	•	-	-
FanCoil operation for heating and cooling	-	-	•	-	•
General KNX functions (incl. light scenes)	-	-	•	•	•
Busch-Watchdog®, 4 channels	-	-	-	•	-

7 Program Overview

7.1 Sensors



6125/01-500 control element, 1gang with bus coupler



6126/01-500 control element, 2gang with bus coupler



6127/01-500 control element, 4gang with bus coupler

The 1gang, 2gang and 4gang control element forms the basic sensory system of the new KNX sensor program. It is supplied with the matching bus coupler.

Function:

- Switching
- Dimming
- Blind
- Value transmitter, 2 objects
- Light scene extension unit
- LED status display
- among others

Features:

- Status illumination
- Orientation illumination
- Write-on rockers
- Anti-theft protection
- Freely programmable
- Two-colour LED

7.2 Pushbutton couplers

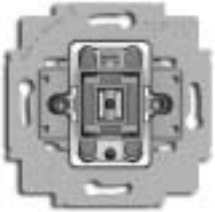

6108/01-500

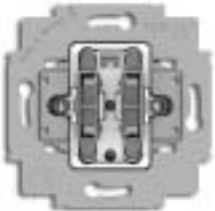

6108/02-500



6108/04-500



6108/05-500

Design without limits

The pushbutton coupler with centre setting opens the entire diversity of the KNX switch range.

Rocker switches from all switch ranges can now be converted to a KNX push button with a simple push-on, and can not only switch on and off but also dim or show the status with an LED (6108/01-500 and 6108/05-500 only). 1gang and 2gang models for single and series rocker switches are available.

Function:

- Switching
- Dimming
- Blind
- Value transmitter, 2 objects
- Light scene extension unit
- LED status display
- among others

KNX – water protected (6108/04-500 and 6108/05-500)

The use of the pushbutton coupler also makes special products usable for KNX. Special models for water-protected installation allow covers from, for example, the ocean® flush-mounted range to be used. This makes the KNX sensory system also suitable for use in the cellar, on the terrace or in the commercial sector.

Temperature range: –25 °C to +45 °C.

7.3 Control elements



6125/02-500 control element, 1/2gang multifunction



6126/02-500 control element, 2/4gang multifunction

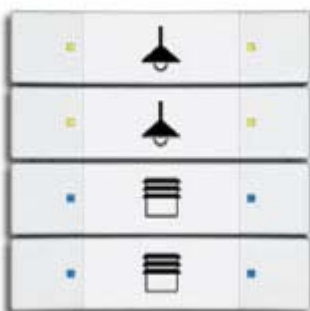

6127/02-500 control element, 4/8gang multifunction

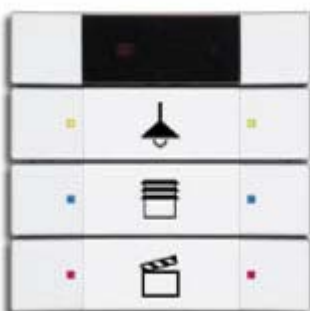

6129/01-500 3gang with IR reception

The control elements are freely programmable and additionally have separate logic and value objects. Each rocker switch can be doubly occupied. They are suitable for Twisted Pair.

Function:

- Switching
- Dimming
- Blind
- Value sender
- Setting the RTC operating mode
- Light scene extension unit
- Logic functions
- LED colour concept
- Switching sequences
- Multiple operation
- and others

General functions:

- Light scene actuator'
- Sequence
- Logic
- Delay
- Staircase lighting
- Preset
- Cyclical telegram
- Flashing
- Gate
- Min/max value transducer
- Threshold value / Hysteresis
- PWM inverter
- Priority

Features:

- Function illumination
- Orientation illumination
- Write-on rockers
- Anti-theft protection
- Freely programmable
- Colour concept
- 10-pin plug connector
- Installed on flush-mounted insert

7.4 Movement detector



6122/01-500 Busch-Watchdog® 180, flush-mounted sensor
Standard select



6122/02-500 Busch-Watchdog® 180, flush-mounted sensor
Comfort II multi-lens

Features:

- 4 channels
- General KNX functions incl. light scenes
- Opening angle 180°
- Protection IP 20
- 1 bis 150 Lux

7.4.1 Detection levels and detection ranges

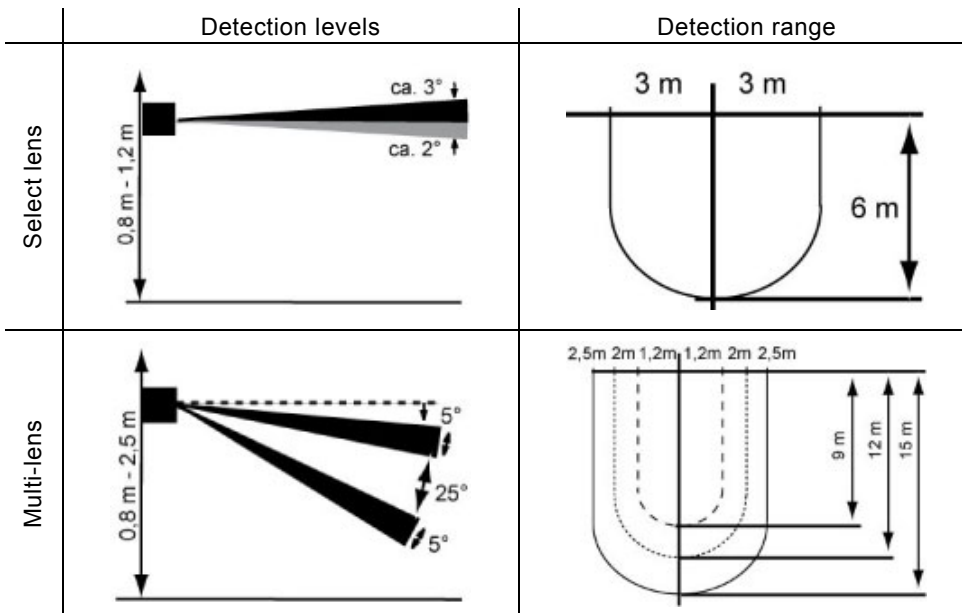

7.4.2 Operating modes

The motion detector can operate in the following modes: "Signaling", "Automatic time control", "Semi-automatic" or "Automatic". A description of the application for the movement detector is found under "Description of application".

7.5 Room thermostat



6124/01-500 Room thermostat



6128/01-500 Room thermostat with 2gang control element



6108/03-500 Room thermostat for object range

The room thermostat has an LCD display which indicates the current room temperature and the respective operating status.

RTC function:

- Set / actual temperature
- Comfort/standby
- Night mode
- Frost protection
- Heat protection
- Heating
- Cooling
- Fan control
- Logic functions

In addition to the room thermostat function the 6128 control elements can be occupied with additional applications.

Function:

- Switching
- Dimming
- Blind
- Value transmitter
- Setting the RTC operating mode
- Light scene extension unit
- Logic functions
- LED colour concept
- Switching sequences
- Multiple operation
- and others

The flush-mounted room thermostat for the object range is used wherever operation is not required. The control is effected via the bus. Aside from commercially available actuating drives the fans can be controlled with up to five steps. This controller also has numerous additional general KNX functions.

8 Operating the room thermostat

8.1 Standard view

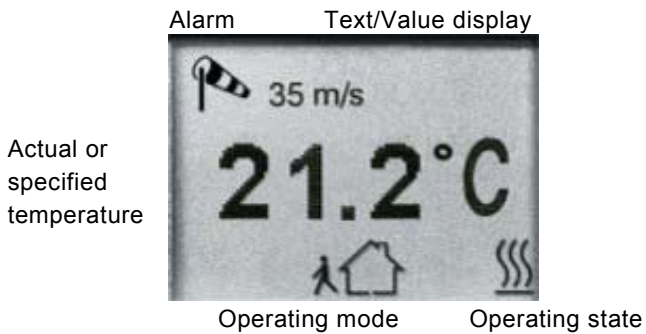

The display of the room thermostat in the standard view shows either the actual or the specified value for the temperature, depending on the parameterization. The current operating state is shown in the right area of the display and the current operating mode in the centre.

8.2 Rocker switches



8.2.1 Function of rocker switches during heating AND cooling

1	<input type="radio"/> Temperature - <input checked="" type="radio"/> Switchover	2	<input type="radio"/> Temperature + <input checked="" type="radio"/> Switchover
3	<input type="radio"/> Comfort <input checked="" type="radio"/> On/Off	4	<input type="radio"/> Standby

Brief press of the button

Long press of the button

The set values for heating and cooling can be changed in the setting level of the RTC.

The set values for heating are displayed to the right of the symbol for "heating" and the set value for cooling to the right of the symbol for "cooling".

The value selected is stored.

With a long press of the button the selection jumps to the next set value. This one can now also be adjusted with a short press of the button.

8.2.2 Function of rocker switches during heating OR cooling

1 <input type="radio"/> Temperature -	2 <input type="radio"/> Temperature +
3 <input type="radio"/> Comfort <input checked="" type="radio"/> On/Off	4 <input type="radio"/> Standby

Brief press of the button

Long press of the button

The two buttons of the control element are used to operate the room thermostat. To reach the setting level of the 6128, press the additional key once. The adjustment is made with the upper rocker switch of the control element. A short press of the left side lowers the setpoint, a short press of the right side raises the setpoint.

8.2.3 Function of the rocker switches for the fan step

1 <input type="radio"/> Temperature -	2 <input type="radio"/> Temperature +
3 <input type="radio"/> Comfort <input checked="" type="radio"/> On/Off	4 <input type="radio"/> FanCoil step

Brief press of the button

Long press of the button

If the room thermostat is programmed for the control of a fan step, the fan step switchover is located on the right button of the second rocker switch from the top. You switch over between three steps and manual mode with a brief press. The left button is used for the switchover between operating modes comfort and standby.

8.2.4 In the view menu

↓	↑
Back	OK

You reach the view menu by pressing the additional key in the setting level again.

Navigate with the top two rocker switches (see above).

Unit

Choose between °C and °F.

Contrast

The contrast can be adjusted in three steps.

Language

German, English, French

Jump-back time

Select a time between 5 seconds and 5 minutes or manual jump-back.

Text-change time

Select a time between 3 seconds and 1 minute or inactive.

Systeminfo

Allow the current firmware version be displayed.

Factory settings

Reset the device to the factory settings. You must first acknowledge before performing the reset.

8.3 Symbols



Standby: Standby mode lowers the temperature below the value of comfort mode. This saves energy and does not cool down the room even during an extended absence.



Comfort: Comfort mode regulates the temperature to suit the occupants while present. It can be called up time-controlled or via a telegram.



Dew point: If an appropriate telegram is received from a dew point sensor, the room thermostat will display the corresponding symbol and cease cooling and merely protect against the heat.



Alarm: The alarm can be freely parameterized. For example, it can occur when an external temperature sensor no longer sends values.



On/Off: The room thermostat can be turned on and off. When turned off, this icon is shown in the display. The device operates in frost protection mode.



Night setback: The temperature can be reduced during the night. This saves energy and makes the night's rest comfortable. The heating starts again automatically the next morning to reach a comfortable temperature for rising.



Frost protection: If parameterized, frost protection will ensure that the temperature does not drop below the desired value. It is the lowest setpoint.



Heat protection: If parameterized, heat protection will ensure that the temperature does not exceed the desired value. It is the highest setpoint.



Condensate: The operation of a fan coil may cause condensate water, which is collected in a container. If the fan coil sends out a telegram when the container is full, the symbol for condensate mode is displayed. The room thermostat immediately switches into heat protection mode.

9 Planner support for RTC

9.1 Operating modes

The room thermostat has four operating modes:

- Frost protection mode (for heating): The room temperature control is inactive; heating is only carried out when the temperature in the room drops to the point where the heating system could sustain damage through freezing.
Heat protection mode (for cooling): The room temperature control is inactive; cooling is only carried out when the temperature has risen to the point where the heat in the room becomes unbearable.
- Comfort mode (for heating and cooling): The setpoint for the room temperature is set to a value that makes the temperature of the room comfortable during "normal use".
- Standby mode (for heating): The room temperature is reduced to the point where heating costs are saved (e.g. during temporary absence), but can be quickly raised to comfort temperature again.
Standby mode (for cooling): The room temperature is only raised to the point where energy costs are saved (e.g. during temporary absence), but can be quickly increased to comfort temperature again.
- Night mode (for heating and cooling): Rooms are not used for longer periods during the night hours; the room temperature is set a comfortable night-time value and can be quickly raised again to the comfort setpoint in the morning.

A switchover between these operating modes can take place either by means of a switching telegram (parameter "Operating mode switchover": "1 bit (3x)") or with 1-byte value telegrams (parameter "Operating mode switchover": "1 byte (2x)").

9.1.1 Operating mode switchover, 1 bit

Frost/heat protection has the highest priority; i.e., switchover to a different mode cannot take place in this case. The frost/heat protection must first be deactivated; by closing an open window, for example. Night mode has the next highest priority, followed by comfort mode. If none of these three operating modes are active, the room thermostat is in standby mode.

9.1.2 Operating mode switchover, 1 byte

Two 1-byte communication objects are made available with operation mode switchover via 1 byte.

The two 1-byte communication objects have different behaviours for receipt of telegram. One object evaluates received telegrams as "normal". This means, for example, if a comfort telegram is received, the room thermostat switches to comfort mode. If a night telegram is received, the room thermostat switches to night mode. This object is controlled, for example, by time switches.

The second object ("Operating mode switchover OMO") can "overwrite" the first. This means, for example, if a frost/heat protection telegram is received, the room thermostat switches to frost or heat protection mode. If frost or heat protection is reset after receipt of a new telegram, the room thermostat activates the mode that is pending on the "normal" object. As a result, it is capable of memorising operating modes. This object is controlled, for example, by binary inputs that record information from window contacts.

The following conditions apply for both 1-byte communication objects:

0 = Auto (only for "Operating mode switchover OMO")

1 = Comfort

2 = Standby

3 = Night

4 = Frost/Heat protection

5 – 255 = not allowed

9.2 Temperature measurement

The room thermostat with display can record the temperature via an internal sensor. Additionally, values can be received from an external sensor or an external temperature sensor via communication objects. The incoming values can be monitored and, if necessary, adjusted. The functions are explained in greater detail in the following.

9.2.1 Internal temperature sensor

The device has an integrated temperature sensor. The measured value enters the control as actual value. The value can also be shown on the display.

In addition, the measured temperature can be transferred to the bus via the 2-byte communication object "Send actual value - temperature sensor", to be shown on the display, for example. Sending takes place in dependence of parameters "Send actual value for change greater than" and "Send actual value cyclically". By default, both parameters are deactivated. This means that at least one setting must be activated if the actual temperature is to be sent.

The setting "Send actual value for change greater than" has the advantage of being able to transmit the smallest change in the measured temperature, adjustable from 0.1 K to 1.0 K, to the bus. The disadvantage is, for example, that at a setting of 0.1 K and a lot of room thermostats within an installation, the load on the bus increases.

The parameter "Send actual value cyclically" has the advantage that the current actual value is sent out continuously, even when the measured value does not change. The disadvantage is that rapid changes may not be registered because the cycle time selected is too large. It should also not be small because of the extreme load the bus is subjected to.

9.2.2 External temperature sensor

In open-plan offices it can be difficult to control the temperature with only a single thermostat. That is why it would be advantageous to divide the room into zones with an additional room thermostat.

To integrate the temperature value of the additional temperature sensor into the temperature control, the parameter "Room temperature measurement" must be set on "Internal and external". The the temperature measured inside and outside can then be additionally weighted. The setting for weighting depend on the local circumstances. If the room thermostat and the additional measuring sensor are positioned equal distances from the heater, in the case of panel heaters, a 50% / 50% setting should provide good control results.

9.3 Monitoring

The "Temperature measurement monitoring" parameter specifies whether the external temperature sensor and the outside temperature are to be monitored. This means that the room thermostat has to receive at least one telegram with the current temperature on the associated communication object within an adjustable time ("Monitoring time of external temperature" and "Monitoring time of outside temperature").

If no telegram is received during monitoring time, the room thermostat assumes that the measuring sensor for the outside temperature or external temperature is defective or no longer connected to the bus.

The room thermostat will then terminate its control and send a predefined control value ("Control value during temperature measurement error") so that the room to be controlled does not overheat or cool down. This control value is sent out until the room thermostat again receives a temperature telegram via the bus and reactivates the control.

9.3.1 Adjustment

If the measured temperature is distorted, such as by the inherent heat of the bus coupler, an "Offset room temperature measurement" can be set.

If additional external temperature recording has been activated and the measured value becomes distorted through the influence of cold or heat, here, too, an offset can be entered.

9.4 Controller

The room thermostat can be used exclusively for heating, exclusively for cooling or for heating and cooling.

If the room thermostat is to heat or cool, the switchover from heating to cooling or cooling to heating can occur automatically by means of the room thermostat. The controller detects automatically whether a control value for heating or cooling is to be sent out. If the automatic switchover is not required, the switchover between heating and cooling can take place by means of an external, central control via the 1-bit object "Switchover heating/cooling". In this setup, the heat and cooling icons are continuously displayed in the respective mode. The object is enabled via parameter "Switchover between heating/cooling". The control value for heating and/or cooling can be sent out on a common communication object "Heating/cooling control value" or on two individual communication objects "Heating control value" and "Cooling control value". If a common object is used, it may be necessary to inform the actuator whether the control value is for heating or cooling. For this, a 1-bit communication object "Switchover heating/cooling" can be enabled via parameter "Switchover between heating and cooling" with setting "Automatic and sending". For activation of heating operating mode a "1" is sent to the bus, for activation of cooling mode a "0".

A common communication object for heating and cooling is required to activate two two-pipe systems, i.e., the same pipeline is used for heating and cooling. Two single communication objects are used for four-pipe systems. Heating and cooling each have their own pipeline system.

Parameter "Number of output channels" specifies whether an object ("1 channel (two-pipe system) for heating and cooling") or two objects ("2 channels (four-pipe system) for heating and cooling") are to be displayed.

Separate control types can be configured each for heating and cooling. One of the following control types can be selected:

- 2-point
- PWM
- Continuous
- Fan coil

The individual control types are described in greater detail in the following.

9.4.1 2-point controller

A 2-point controller has two output states that alternate in dependence of the actual value. If the actual value is above the parameterised setpoint, control value "0" is sent on the bus. If the actual value is below the parameterised setpoint, control value "1" is sent.

A 2-point controller should be used when the control value is to alternate only between the two states ON and OFF, such as an electrothermal valve that is connected to a switch actuator, for example. A 2-point controller can quickly correct control variations in case of large changes in the control variable, but never comes to rest.

To avoid rapid oscillations of the output states, the 2-point controllers always have a built-in hysteresis that varies around the setpoint. The hysteresis can have different size parameters. For example, if the setpoint during heating mode is 21 °C and the hysteresis is 1.0 K, the controller switches on when the value falls below 20.5 °C and switches off again when exceeding 21.5 °C. The "Hyteresis" parameter to be set, on the one hand responds to how quickly the heating can heat the room or how quickly the air-conditioning cools the room, and on the other hand to the desired temperature of the people in the room. The hysteresis should not be set too small, otherwise the switching actuator will constantly open and close. The hysteresis should also not be set too large, otherwise the temperature fluctuations in the room will be too large.

9.4.2 Continuous controller

A continuous controller has a continuously changing control value which can accept values between 0 and 100%. For the KNX this control value signal is converted to a 1-byte value, which means that control value 0% corresponds to value "0" and control value 100% to value "255".

Continuous controllers with a 1-byte control value, for example, can be used to activate electromotive actuating drives. They translate the value received directly into the valve position via an installed motor. This results in optimum control.

The 1-byte control value of a continuous controller can also be sent to KNX heating actuators which convert the 1-byte signal into a PWM size. This allows electrothermal valves to be activated. Here it is practical to limit the dynamic range since electrothermal valves require time to open and close. This takes place via parameters "Minimum control value" or "Maximum control value". If, for example, a maximum control value of 80% is specified, the control will always automatically send the value 255 when the control value of 204 has been exceeded.

To protect the bus from unnecessary loads the change of the control value that is permitted to be sent to the bus can be set. The setting is in percent. The control value sent, unless it has changed, is specified by means of a cycle time. The cycle time selected should not be too small (e.g. every 10 min.).

9.4.3 PWM controller

The PWM controller has the same continuous control as the continuous controller. The difference is that with a PWM controller the 1-byte control value (0...255) is converted into an On/OFF switching relationship (0 and 1). If, for example, a control value of 70% is to be issued, at a pre-set cycle time of 10 minutes the switch-on time will be 7 minutes and the switch-off time 3 minutes.

This transfers the advantages of the continuous control (control at the desired setpoint, no overshooting) to drives which are designed only for On/Off switching signals, such as electrothermal drives.

To optimise the controlling characteristics of the heating/cooling system, the "PWM control value cycle time" can be set. To set a practical cycle time, the type of heating or cooling as well as the actuating drive used should be taken into consideration. The following recommendations can be used:

- Electrothermal actuating drive
To fully open an electrothermal control valve takes approximately 2-3 minutes. That is why a cycle time of less than 15 minutes is not practical.
- Floor heating
The time constant of floor heating is rather large. That is why a cycle time of 20 minutes is sufficient.
- Hot water heating
Her electrothermal drives are generally used. A cycle time of 15 minutes will produce excellent control results.
- Electro-convector heating
Cycle times of between 10 and 15 minutes are recommended, depending on the electric heating system and the spatial circumstances.

9.4.4 Fan coil

With the selection of fan coil for "Control types" the control value output takes place in the same way as described under Continuous control.

With 'fan coil' there is the additional option of activating fan stages via a 1-byte or three 1-bit communication objects. The added connection of the fan stages heats or cools the room correspondingly faster.

Which fan stage is to be active at which control value is specified on a separate tab "Fan coil heating" or "Fan coil cooling". Here it should be ensured that threshold value stage 1 must always be smaller than threshold value stage 2, which in turn must be smaller than threshold value stage 3.

9.4.5 Control parameter for PWM controller and continuous controller (Fan coil)

For continuous control behaviour and for a switching PWM controller, the preset control parameters can be used via the installation type of the heating or cooling system. If different control parameters are required, they should be set individually via user parameterization. User parameterization should only be used by persons with adequate experience in control technology.

The setting "User parameterization" can be used to set the "Proportional range (Xp)" and the "Readjust time (Tn)". The proportional range lies below and above the preset setpoint and determines the regulating speed. The readjust time amounts to three times the delay time. The delay time is determined by the reversing tangent of the heating curve of the room. In general, the more inactive the overall system, the larger the parameterization values should be.

9.4.6 Two-stage heating / cooling

In specific instances such as when using underfloor heating, it may be necessary to install a quick additional stage for the heat control in order to warm up the room rapidly. When the room thermostat is preset to "Additional heating stage active", it has a second heating system with switching control that regulates with the 1-byte values 0% and 100%.

The parameters "Distance of the additional stage" and "Hysteresis (one-sided)" enable you to specify when the additional stage switches on and off. For instance, if the setpoint for the additional stage is 18 °C and the hysteresis is 0.5 K (one-sided), the controller switches on at 18 °C and off again at 18.5 °C.

The settings for the additional heating stage apply equally to the additional cooling stage, the only difference being that in the case of cooling, when a set temperature has been exceeded, an additional cooling stage is switched on to cool the room faster.

Since several actuating drives close (opened de-energised) at a 1-bit value of "1" or a 1-byte value of "255" and open at "0", the mode of the control value can be changed via "Invert control value".

9.5 Set values

The room thermostat can operate with dependent or individual set values. Both versions are explained in greater detail in the following.

9.5.1 Dependent setpoints

In case of dependent setpoints there are two basic setpoints, one for heating ("Heating setpoint comfort operation" and one for cooling ("Cooling setpoint comfort operation").

The settings "...lowering standby/night mode" or "...raising standby/night mode". This means, for example, when 21 °C has been set for "Heating setpoint comfort mode" and 2 K was specified for "Lower heating setpoint standby", the heating setpoint in standby mode is lowered by 2 K to 19 °C. If 4 K has been specified for "Lower heating setpoint standby", the setpoint for "Heating setpoint for night mode" is 17 °C.

The dependence of the setpoints are also maintained after a manual setpoint shift. For example, when the user has effected a setpoint shift of 1 K upward to 22 °C for the parameterized temperature "Heating setpoint comfort mode", this value will be lowered by 2 K to 20 °C when comfort mode is activated. When night mode is called up, the value will be lowered by 4 K, resulting in a setpoint of 18 °C.

The user can manually change the parameterized setpoints via the two buttons "Raise temperature" or "Lower temperature". The change between "Heating setpoint comfort mode" and "Cooling setpoint comfort mode" is made via a long press (approx. 1 sec.) of button "Raise temperature" to heating setpoint and on button "Lower temperature" to cooling setpoint.

The two specified setpoints for heating and cooling can also be changed as often as desired via the bus without the ETS. Here a 2-byte temperature value must be sent to the communication object "Base setpoint - control". Depending on whether heating or cooling is currently active, the value is stored as "Heating setpoint comfort mode" or "Cooling setpoint comfort mode". The values received are stored in the memory of the device and are retained in case of bus power failure and subsequent return of bus voltage. This makes it possible to send new base setpoints to the device via a visualization when the use of a room changes, for example.

New parameterization is not required. In case of a manual adjustment and dependent setpoints the reference base setpoint is taken into consideration. This is used to specify whether the base setpoint refers to the comfort temperature for heating, cooling or the mid-range temperature between heating and cooling.

"Setpoint heating" is the default setting. In regions where the cooling function is more important, it is recommended that you change this parameter to "Setpoint cooling". This makes it easier to set the room thermostat and raise the cooling setpoint (standby temperature cooling and night setback cooling).

9.5.2 Individual setpoints

When individual setpoints are used, individual setpoints are defined for each operating mode ("Heating setpoint comfort mode", "Heating setpoint standby", "Heating setpoint night mode", "Cooling setpoint standby" and "Cooling setpoint night mode").

Different to the dependent setpoints, the individual setpoints are also maintained after a manual setpoint shift. For example, when the user has effected a setpoint shift of the parameterized temperature "Heating setpoint comfort mode" upward or downward, the parameterized value "Heating setpoint standby" will always be called up when standby mode is activated.

This means that only the fixed setpoints that are stored will be called up for the individual operating modes.

The user can manually change the parameterized setpoints via the two buttons "Raise temperature" or "Lower temperature".

The change between "Heating setpoint comfort mode" and "Cooling setpoint comfort mode" is made via a long press (approx. 1 sec.) of button "Raise temperature" to heating setpoint and on button "Lower temperature" to cooling setpoint.

The specified setpoints can be changed as often as desired via the bus also without the ETS. For this, a 2-byte temperature value must be sent to the corresponding communication object "Setpoint heating comfort", "Setpoint heating standby", "Setpoint heating night mode", "Setpoint frost protection", "Setpoint cooling comfort", "Setpoint cooling standby", "Setpoint cooling night mode" or "Setpoint heat protection". The values received are stored in the memory of the device and are retained in case of bus power failure and subsequent return of bus voltage. This makes it possible to send new setpoints to the device via a visualization when the use of a room changes, for example. New parameterization is not required.

9.5.3 Minimum distance

The adjustable parameter "Minimum distance between heating and cooling" is active both for the dependent and the individual setpoints.

The minimum distance is always between "Heating setpoint comfort mode" and "Cooling setpoint comfort mode". It serves as a buffer zone to prevent the the two setpoints from interfering with each other.

Example:

Individual setpoints has been selected. The "Heating setpoint comfort mode" is 21 °C and the "Cooling setpoint comfort mode" is set on 26 °C. The dead zone between heating and cooling is 3 K. If a heating setpoint is now shifted upwards, the dead zone also shifts upwards. If the shift exceeds a temperature of 23 °C, the "Cooling setpoint comfort mode" will also shift upwards so that a minimum distance of 3 K is always guaranteed between heating and cooling.

If a cooling setpoint is shifted downwards, the dead zone also shifts downwards. If the shift exceeds a temperature of 24 °C, the "Heating setpoint comfort mode" will also shift downwards so that a minimum distance is also guaranteed in this case.

9.6 Fan coil, general

The ventilation convectors, also called fan convectors or fan coil units, are used for decentralized heating and cooling. They are installed in the room and supplied via a central heating and cooling system. There are two-pipe and four-pipe systems. There are multi-stage ventilators within a fan coil unit that enable fast adjustment to the room temperature to be made according to individual requirements. The fan coil room thermostat with display can activate up to three fan stages either manually or automatically.

The fan stages can be activated in three ways:

- via 1-bit values,
i.e., a 1-bit communication object "Fan coil stage ... switching" is made available for each fan stage. This required for "normal switch actuators. ((When using KNX switch actuators and fan coil units, the connecting instructions for the fan coil unit are to be observed).
- via 1-byte object as numerical value 0-3,
i.e. there is a 1-byte communication object "Fan stage manual 1 byte" which is connected with a corresponding communication object of a fan coil actuator. Here the value 0 = OFF 1 = stage 1 2 = stage 2 3 = stage 3
- via 1-byte object as constant value 0-100%,
i.e. there is a 1-byte communication object "Fan stage manual 1 byte" which is connected with a corresponding communication object of a fan coil actuator. During manual stage switchover the stage threshold values that are set on tab heating or cooling are sent out. In heating mode the threshold values for heating, in cooling mode the threshold values for cooling. To ensure that the fan coil unit switches the fan stages, the parameters of the associated fan coil actuator must be set accordingly.

Via parameter "Evaluate fan stage status byte" a 1-byte communication object "Fan coil operating state", which is connected with a corresponding object of a fan coil actuator, can be enabled. This allows the fan coil room thermostat evaluate which fan stage is actually active on the fan coil actuator. The display corresponds to the value of the communication object (0 = OFF, 1 = stage 1, 2 = stage 2, 3 = stage 3).

The parameter "Evaluate operation status byte" activates a 1-bit communication object "Receive during operation - actuator monitoring". Cyclical telegrams from the fan coil actuator can be received and evaluated on this object. This allows the room thermostat to check whether the fan coil actuator is still operating and can be activated. If the fan coil actuator has a problem and can no longer send cyclical telegrams, the room thermostat will indicate this on the display with the "Error" symbol. If the error on the fan coil actuator has been rectified and cyclical telegrams can be received, the "Error" on the display is removed and the room thermostat will again function as "Normal".

The cycle time setting "In operation" in the fan coil actuator should be selected at least twice as large as the monitoring time in the room thermostat ("Sending cycle time of actuator in sec."). A practical cycle time for the actuator is approximately 60 seconds with a monitoring time of 120 seconds for the room thermostat.

To prevent an excessive noise level in hotel rooms during the silent period in the night, a "Stage limitation for night mode" can be set. This means that during night mode only the fan stage that has been set is automatically switched to. All fan stages can be activated again when changing to a different operating mode.

Parameter "Stage limitation for night mode" can be used to set a limit to "Stage 2" or "Stage 1" or the ventilation can be completely deactivated.

9.6.1 Summer compensation

To save energy and to maintain a reasonable temperature difference when entering an air-conditioned building, the room temperature should be adjusted in relation to the external temperature (summer compensation according to DIN 1946). The room temperature is raised by adjusting the "Cooling setpoint comfort mode".

Raising the room temperature does not, however, mean that you heat up the room. Rather the adjustment is intended to allow the room temperature without cooling to increase to a specified value. This prevents the cooling system from further reducing the room temperature to 24 °C with an external temperature of 35 °C.

However, the activation of summer compensation makes an external temperature sensor necessary that sends its measured value to the KNX for evaluation by the room thermostat with display.

The following parameters are available for summer compensation:

- "Summer compensation lower outside temperature value"
- "Summer compensation upper outside temperature value"
- "Summer compensation lower setpoint offset"
- "Summer compensation upper setpoint offset"

The value of the lower and upper temperature is used to specify from and to which temperature value a setpoint correction is to be made.

The lower and upper setpoint offset is used to specify by how many Kelvin the setpoint specified in the parameters or by the user via a manual shift is to be adjusted during summer compensation.

Typical values for the summer compensation are:

- 20 °C: lower outside temperature value
- 32 °C: upper outside temperature value
- 0 K: lower setpoint offset
- 4 K: upper setpoint offset

That means that a flowing setpoint increase of 0 to 4 K occurs if the outside temperature increases from 20°C to 32°C.

Example:

In the lower diagram 25 °C has been parameterized for "Cooling setpoint comfort". When the outside temperature rises, the parameterized setpoint is raised starting from an outside temperature of 20 °C flowing from 25 °C to 29 °C. The 29 °C are reached at an outside temperature of 32 °C. After this the setpoint is no longer raised even though the outside temperature rises.

Note:

When compensation is active, CO is shown on the display of the room thermostat.

Objects, room thermostat

No.	Object name	Data type	Flags
0	Control ON/OFF	1 Bit / DPT_switch	C, W, T, U
0	Current temperature	2 Byte / DPT_Value_2_Float	C, W, U
0	Fault, actual temperature	1 Bit / DPT_switch	C, W, T, U
0	Actual setpoint	2 Byte / DPT_Value_2_Float	C, T
0	Frost/heat protection	1 Bit / DPT_switch	C, W, T, U
0	Comfort	1 Bit / DPT_switch	C, W, T, U
0	Night mode	1 Bit / DPT_switch	C, W, T, U
0	Heating control value	1 Bit / DPT_switch 1 Byte / DPT_scaling	C, W, T, U
0	Status heating	1 Bit / DPT_switch	C, W, T, U
0	Additional Heating Stage	1 Bit / DPT_switch 1 Byte / DPT_scaling	C, T
0	Cooling control value	1 Bit / DPT_switch 1 Byte / DPT_scaling	C, W, T, U
0	Status cooling	1 Bit / DPT_switch	C, W, T, U
0	Additional Cooling Stage	1 Bit / DPT_switch 1 Byte / DPT_scaling	C, T
0	Switchover heating (1) / cooling (0)	1 Bit / DPT_switch	C, W, T, U
0	Basic set value heating frost protection	2 Byte / DPT_Value_2_Float	C, W, T, U
0	Basic set value heating comfort	2 Byte / DPT_Value_2_Float	C, W, T, U
0	Basic set value heating standby	2 Byte / DPT_Value_2_Float	C, W, T, U
0	Basic set value heating night mode	2 Byte / DPT_Value_2_Float	C, W, T, U
0	Basic set value cooling frost protection	2 Byte / DPT_Value_2_Float	C, W, T, U
0	Basic set value cooling comfort	2 Byte / DPT_Value_2_Float	C, W, T, U
0	Basic set value cooling standby	2 Byte / DPT_Value_2_Float	C, W, T, U
0	Basic set value cooling night mode	2 Byte / DPT_Value_2_Float	C, W, T, U
0	Reset onsite operation	1 Bit / DPT_switch	C, W, U
0	Dew point alarm	1 Bit / DPT_switch	C, W, U
0	Condensate water alarm	1 Bit / DPT_switch	C, W, U
0	Outside temperature	2 Byte / DPT_Value_2_Float	C, W, U
0	Shading	1 Bit / DPT_updown	C, T
0	Summer compensation	1 Bit / DPT_switch	C, T
0	Units switchover	1 Bit / DPT_switch	C, W, U
0	Current set value for heating	2 Byte / DPT_Value_2_Float	C, W, T, U
0	Current set value for cooling	2 Byte / DPT_Value_2_Float	C, W, T, U
0	Basic set value for group master operation	2 Byte / DPT_Value_2_Float	C, W
0	Superimposed operating mode	8 Bit / DPT_HVAC_mode	C, W, T, U
0	Operating mode	8 Bit / DPT_HVAC_mode	C, W, T, U
0	FanCoil manual/automatic	1 Bit / DPT_switch	C, W, T, U
0	FanCoil step	8 Bit / DPT_Value_1_u_Ucount	C, W, T, U

10 Description of application

10.1 Switching, rocker total

With the "Switch, rocker total" application, an operation of the right or left side of the rocker sends out a switch telegram. The "Switch, rocker total" application differentiates here between whether the rocker is operated on the left or right side.

Switching objects, rocker total

No.	Object name	Data type	Flags
0	Switching	1 Bit EIS1 / DPT 1.001	C, W, T, U

10.2 Switching, rocker left/right

With the application "Switching, rocker left/right" a switch telegram is sent when the rocker is actuated and/or released. "Rocker left/right" does not differentiate whether the rocker is actuated on the right or the left side. In each case, the application makes a separate set of parameters and communication objects available for the right and left side of the rocker. The application enables a switching function to be implemented with one side of the rocker and to assign an additional "button-oriented" function to the other side of the rocker.

Switching objects, rocker left/right

No.	Object name	Data type	Flags
0	Switching	1 Bit EIS1 / DPT 1.001	C, W, T, U

10.3 Dimming, rocker total

With the "Dimming, rocker total" application, a rocker has communication objects for switching and for dimming. A distinction is made between short and long button contact.

The "Dimming, rocker total" application differentiates between whether the rocker is operated on the left or right side. The "Principle of operation of the rocker for ..." parameter allows adjustment of whether the left or right side switches on or off or whether it is dimmed brighter or darker.

Dimming objects, rocker total

No.	Object name	Data type	Flags
0	Switching	1 Bit EIS2 / DPT 1.001	C, W, T, U
1	Relative dimming	4 Bit EIS2 / DPT 3.007	C, T

10.4 Dimming, rocker left/right

With the "Dimming, rocker left/right" application, a rocker switch has communication objects for switching and for dimming. A distinction is made between short (switching) and long (dimming) button contact.

The "Dimming, rocker left/right" application does not differentiate between whether the rocker is operated on the left or right side. In each case, the application makes a separate set of parameters and communication objects available for the right and left side of the rocker.

The application makes it possible to dim a light via one side of the rocker and to assign an additional "button-orientated" function to the other side.

Dimming objects, rocker left/right

No.	Object name	Data type	Flags
0	Switching	1 Bit EIS2 / DPT 1.001	C, W, T, U
1	Relative dimming	4 Bit EIS2 / DPT 3.007	C, T

10.5 Blind, rocker total

Via the application "Blind, rocker total", blind movement and/or slat adjustment commands can be sent to connected shutting actuators with a short or long contact of the rocker. A short button contact always triggers a slat adjustment or stop command and a long button contact always triggers a move command.

The control always remembers the last action performed on the side of the rocker switch that is assigned with the "Blind, rocker total" application. If a blind was lowered and halted at half height via a short button contact, then a renewed long button contact will raise the blind.

Blind objects, rocker total

No.	Object name	Data type	Flags
0	Adjusting(1 Bit)	1 Bit EIS7 / DPT 1.008	C, T
0	Adjusting (1 Byte)	1 Byte EIS6 / DPT 5.001	C, T
1	Move (1 Bit)	1 Bit EIS7 / DPT 1.007	C, T
1	Move(1 Byte)	1 Byte EIS6 / DPT 5.001	C, T

10.6 Blind, rocker left/right

Via the application "Blind, rocker left/right", blind movement and/or slat adjustment commands can be sent to connected shutting actuators with short or long actuation of the rocker. A short button contact always triggers a move command and a long button contact always triggers a slat adjustment or stop command.

The application "Blind, rocker left/right" makes a separate set of parameters and communication objects available in each case for the right or left side of the rocker. This facilitates control of a Venetian blind with one side of the rocker and assigning an additional "Rocker, left/right" function to the other side of the rocker.

The control always remembers the last action performed on the side of the rocker that is assigned with the "Blind, rocker left/right" application. If a blind was lowered and halted at half height via a long button contact, then a renewed short button contact will raise the blind.

Blind objects, rocker left/right

No.	Object name	Data type	Flags
0	Adjusting (1 Bit)	1 Bit EIS7 / DPT 1.007	C, W, T, U
0	Adjusting(1 Byte)	1 Byte EIS6 / DPT 5.001	C, W, T, U
1	Moving(1 Bit)	1 Bit EIS7 / DPT 1.008	C, W, T, U
1	Moving(1 Byte)	1 Byte EIS6 / DPT 5.001	C, W, T, U

10.7 Short/long operation, rocker left/right

Via the application "Short/long operation, rocker left/right", different values can be sent out with a short and/or long actuation of the rocker switch.

The "Short/long operation, rocker left/right" application does not differentiate between whether the rocker is actuated on the left or right side. In each case, the application makes a separate set of parameters and communication objects available for the right and left side of the rocker.

The application facilitates making two separate functions available on one side of the rocker that can be called up via a short or long button contact and assigning the other side of the rocker switch with an additional "button-orientated" function.

Short/long operation objects, rocker left/right

No.	Object name	Data type	Flags
0	Adjusting(1 Bit)	1 Bit EIS7 / DPT 1.007	C, W, T, U
0	Adjusting(1 Byte)	1 Byte EIS6 / DPT 5.001	C, W, T, U
1	Moving (1 Bit)	1 Bit EIS7 / DPT 1.008	C, W, T, U
1	Moving (1 Byte)	1 Byte EIS6 / DPT 5.001	C, W, T, U

10.8 Value sender, rocker total

With the "Value sender, rocker total" application, a telegram with the predefined value is sent out at an actuation of the right or left side of the rocker.

The "Value sender, rocker total" application differentiates here between whether the rocker is actuated on the left or right side.

Value sender objects, rocker total

No.	Object name	Data type	Flags
0	Switching value(1 Bit)	1 Bit EIS1 / DPT 1.001	C, W, T, U
0	Switching value(1 Byte 0..100 %)	1 Byte EIS6 / DPT 5.001	C, W, T, U
0	Switching value(1 Byte 0..255)	1 Byte EIS14 / DPT 5.010	C, W, T, U
0	Switching value(2 Byte Float)	2 Byte EIS5 / DPT 9.xxx	C, W, T, U
0	Switching value(2 Byte Signed)	2 Byte EIS10 / DPT 7.001	C, W, T, U
0	Switching value (2 Byte Unsigned)	2 Byte EIS10 / DPT 8.001	C, W, T, U
0	Switching value (4 Byte Float)	4 Byte EIS9 / DPT 14.xxx	C, W, T, U
0	Switching value (4 Byte Signed)	4 Byte EIS11 / DPT 13.001	C, W, T, U
0	Switching value (4 Byte Unsigned)	4 Byte EIS11 / DPT 12.001	C, W, T, U

10.9 Value sender, rocker left/right

With the "Value sender, rocker left/right" application, a telegram with a predefined value is sent out at an actuation or release of the rocker.

The "Value sender, rocker left/right" application does not differentiate between whether the rocker is actuated on the left or right side. In each case, the application makes a separate set of parameters and communication objects available for the right and left side of the rocker.

The application enables realising a switching function via one rocker side, while the other rocker side can be assigned with an additional "button-orientated" function.

Value sender objects, rocker left/right

No.	Object name	Data type	Flags
0	Switching (1 Bit)	1 Bit EIS1 / DPT 1.001	C, W, T, U
0	Switching (1 Byte 0..100 %)	1 Byte EIS6 / DPT 5.001	C, W, T, U
0	Switching (1 Byte 0..255)	1 Byte EIS14 / DPT 5.010	C, W, T, U
0	Switching (2 Byte Float)	2 Byte EIS5 / DPT 9.xxx	C, W, T, U
0	Switching (2 Byte Signed)	2 Byte EIS10 / DPT 7.001	C, W, T, U
0	Switching (2 Byte Unsigned)	2 Byte EIS10 / DPT 8.001	C, W, T, U
0	Switching (4 Byte Float)	4 Byte EIS9 / DPT 14.xxx	C, W, T, U
0	Switching (4 Byte Signed)	4 Byte EIS11 / DPT 13.001	C, W, T, U
0	Switching (4 Byte Unsigned)	4 Byte EIS11 / DPT 12.001	C, W, T, U

10.10 LED function

With the "LED function" application, the LED of the rocker can be used for orientation lighting, for status indication or for function display. The LED can light up in different colours. The LED can also flash for alarm display and/or scene storage display.

LED function objects

No.	Object name	Data type	Flags
0	Status (1 Bit)	1 Bit EIS1 / DPT 1.001	C, W, U
0	Status (1 Byte 0..100 %)	1 Bit EIS6 / DPT 5.001	C, W, U
1	Day / Night mode (1 Bit)	1 Bit EIS1 / DPT 1.001	C, W, U
2	Proximity (1 Bit)	1 Bit EIS1 / DPT 1.001	C, W, U
3	Alarm (DPT_Alarm)	1 Bit / DPT_Alarm	C, W, U
4	Scene storage (DPT_Scene_Control)	1 Byte / DPT 18.001	C, W, U

10.11 Setting RTC operation mode

With the "Setting the RTC operation mode" application, an operation mode switchover for connected room temperature controllers can be carried out via an actuation of a rocker side.

Depending on the setting of the "Object type for output" parameter, the application offers either three 1-bit communication objects "Operation mode comfort", "Operation mode night", and "Operation mode frost" or a 1-byte communication object "Operation mode".

The selection "1-bit" is used for the control of room temperature controllers that have 1-bit communication objects for operation mode switchover. The "1-byte" selection is used for the control of room temperature controllers that have a 1-byte communication object for operation mode switchover to KNX. In this case, the values mean

0 = Auto

1 = Comfort

2 = Standby

3 = Night

4 = Frost / Heat protection

The function can be temporarily blocked via a 1-bit "Enable" communication object.

Setting RTC operation mode objects

No.	Object name	Data type	Flags
0	Enable	1 Bit EIS1 / DPT 1.001	C, W, U
1	Operation mode Comfort(1 Bit)	1 Bit EIS1 / DPT 1.001	C, T
2	Operation mode Night(1 Bit)	1 Bit EIS1 / DPT 1.001	C, T
3	Operation mode Frost(1 Bit)	1 Bit EIS1 / DPT 1.001	C, T
4	Operation mode (1 Byte)	1 Byte / DPT 20.102	C, T

10.12 Value sender, 2 objects, rocker left/right

With the "Value sender, 2 objects, rocker left/right" application, two telegrams with predefined values from two different communication objects can be sent out by actuation and/or upon release of the rocker.

The application "Value sender, 2 objects, rocker left/right" makes a separate set of parameters and communication objects available in each case for the right or left side of the rocker.

For example, the application facilitates the sending out of a switching function and a floating point value with the actuation of one rocker side and assigning an additional "button orientated" function to the other side of the rocker.

Value sender objects, 2 objects, rocker left/right

No.	Object name	Data type	Flags
0	Switching (rising flank) (1 Bit)	1 Bit EIS1 / DPT 1.001	C, W, T, U
0	Switching (rising flank) (1 Byte 0..100 %)	1 Byte EIS6 / DPT 5.001	C, W, T, U
0	Switching (rising flank) (1 Byte 0..255)	1 Byte EIS14 / DPT 5.010	C, W, T, U
0	Switching (rising flank) (2 Byte Float)	2 Byte EIS5 / DPT 1.xxx	C, W, T, U
0	Switching (rising flank) (2 Byte Signed)	2 Byte EIS10 / DPT 8.001	C, W, T, U
0	Switching (rising flank) (2 Byte Unsigned)	2 Byte EIS10 / DPT 7.001	C, W, T, U
0	Switching (rising flank) (4 Byte Float)	4 Byte EIS9 / DPT 14.xxx	C, W, T, U
0	Switching (rising flank) (4 Byte Signed)	4 Byte EIS11 / DPT 13.001	C, W, T, U
0	Switching (rising flank) (4 Byte Unsigned)	4 Byte EIS11 / DPT 12.001	C, W, T, U
1	Switching (falling flank) (1 Bit)	1 Bit EIS1 / DPT 1.001	C, W, T, U
1	Switching (falling flank) (1 Byte 0..100 %)	1 Byte EIS6 / DPT 5.001	C, W, T, U
1	Switching (falling flank) (1 Byte 0..255)	1 Byte EIS14 / DPT 5.010	C, W, T, U
1	Switching (falling flank) (2 Byte Float)	2 Byte EIS5 / DPT 9.xxx	C, W, T, U
1	Switching (falling flank) (2 Byte Signed)	2 Byte EIS10 / DPT 7.001	C, W, T, U
1	Switching (falling flank) (2 Byte Unsigned)	2 Byte EIS10 / DPT 8.001	C, W, T, U
1	Switching (falling flank) (4 Byte Float)	4 Byte EIS9 / DPT 14.xxx	C, W, T, U
1	Switching (falling flank) (4 Byte Signed)	4 Byte EIS11 / DPT 13.001	C, W, T, U
1	Switching (falling flank) (4 Byte Unsigned)	4 Byte EIS11 / DPT 12.001	C, W, T, U

10.13 Light scene extension unit with memory function

Via the application "Light scene extension unit with memory function", a predefined light scene number is called up when the rocker is actuated.

The application "Light scene extension unit with memory function" makes a separate set of parameters and communication objects available in each case for the right or left side of the rocker.

The application facilitates calling up a light scene via a rocker side while the other rocker side can be assigned an additional "button orientated" function.

The user has the option to trigger a light scene memory command with a long button contact.

Light scene extension unit objects with memory function

No.	Object name	Data type	Flags
0	Switching	1 Byte EIS1 / DPT 1.001	C, W, T, U

10.14 Step switch, rocker total

The application "Step switch, rocker total" facilitates step-type switching. This means that the user can trigger different switching processes with each new operation of the left or right side of the rocker.

Example:

First operation (right rocker side) switches lamp 1 on.

Second operation (right rocker side) switches lamp 1 off and lamp 2 on.

Third operation (right rocker side) switches lamp 2 off and lamp 3 on.

Fourth operation (left rocker side) switches lamp 3 off and lamp 2 on.

Fifth operation (left rocker side) switches lamp 2 off and lamp 1 on.

etc.

The application differentiates between whether the left or right side of the rocker was operated. Depending on the setting, one lower or one higher step can be switched to.

Up to five switching steps can be activated.

Step switch objects, rocker total

No.	Object name	Data type	Flags
0	Switching step 1	1 Bit EIS1 / DPT 1.001	C, W, T
1	Switching step 2	1 Bit EIS1 / DPT 1.001	C, W, T
2	Switching step 3	1 Bit EIS1 / DPT 1.001	C, W, T
3	Switching step 4	1 Bit EIS1 / DPT 1.001	C, W, T
4	Switching step 5	1 Bit EIS1 / DPT 1.001	C, W, T

10.15 Step switch, rocker left/right

The application "Step switch, rocker left/right" facilitates step-type switching. This means that the user can trigger different switching processes with each new operation of the rocker switch.

Example:

First operation switches lamp 1 on.

Second operation switches lamp 1 off and lamp 2 on.

Third operation switches lamp 2 off and lamp 3 on.

Fourth operation switches lamp 3 off and lamp 1 on.

etc.

Up to five switching steps can be activated.

In each case, the application "Step switch, button oriented" makes a separate set of parameters and communication objects available for the right or left side of the rocker.

The application enables realising switching functions via one rocker side while the other rocker side can be assigned with an additional "button orientated" function.

Step switch objects, rocker left/right

No.	Object name	Data type	Flags
0	Switching step 1	1 Bit EIS1 / DPT 1.001	C, W, T
1	Switching step 2	1 Bit EIS1 / DPT 1.001	C, W, T
2	Switching step 3	1 Bit EIS1 / DPT 1.001	C, W, T
3	Switching step 4	1 Bit EIS1 / DPT 1.001	C, W, T
4	Switching step 5	1 Bit EIS1 / DPT 1.001	C, W, T

10.16 Multiple operation, rocker left/right

With the "Multiple actuation, rocker left/right" application, a differentiation can be made between a single, double, triple, quadruple or quintuple actuation of the rocker. Different values can be sent out for every operation: single, double, triple, quadruple, or quintuple.

The application "Multiple actuation, rocker left/right" makes a separate set of parameters and communication objects available in each case for the right or left side of the rocker. It is therefore possible to realise a multiple operation via one side of the rocker and assigning a "button-orientated" function to the other side of the rocker.

Multiple actuation objects, rocker left/right

No.	Object name	Data type	Flags
0	Switching 1, multiple actuation (1 Bit)	1 Bit EIS1 / DPT 1.001	C, W, T
0	Switching 1, multiple actuation (1 Byte 0..100 %)	1 Byte EIS6 / DPT 5.001	C, W, T
0	Switching 1, multiple actuation (1 Byte 0..255)	1 Byte EIS14 / DPT 5.010	C, W, T
0	Switching 1, multiple actuation (2 Byte Float)	2 Byte EIS5 / DPT 9.xxx	C, W, T
0	Switching 1, multiple actuation (2 Byte Signed)	2 Byte EIS10 / DPT 8.001	C, W, T
0	Switching 1, multiple actuation (2 Byte Unsigned)	2 Byte EIS10 / DPT 7.001	C, W, T
0	Switching 1, multiple actuation (4 Byte Float)	4 Byte EIS9 / DPT 14.xxx	C, W, T
0	Switching 1, multiple actuation (4 Byte Signed)	4 Byte EIS11 / DPT 13.001	C, W, T
0	Switching 1, multiple actuation (4 Byte Unsigned)	4 Byte EIS11 / DPT 12.001	C, W, T
1	Switching 2, multiple actuation (1 Bit)	1 Bit EIS1 / DPT 1.001	C, W, T
1	Switching 2, multiple actuation (1 Byte 0..100 %)	1 Byte EIS6 / DPT 5.001	C, W, T
1	Switching 2, multiple actuation (1 Byte 0..255)	1 Byte EIS14 / DPT 5.010	C, W, T
1	Switching 2, multiple actuation (2 Byte Float)	2 Byte EIS5 / DPT 9.xxx	C, W, T
1	Switching 2, multiple actuation (2 Byte Signed)	2 Byte EIS10 / DPT 8.001	C, W, T
1	Switching 2, multiple actuation (2 Byte Unsigned)	2 Byte EIS10 / DPT 7.001	C, W, T
1	Switching 2, multiple actuation (4 Byte Float)	4 Byte EIS9 / DPT 14.xxx	C, W, T
1	Switching 2, multiple actuation (4 Byte Signed)	4 Byte EIS11 / DPT 13.001	C, W, T
1	Switching 2, multiple actuation (4 Byte Unsigned)	4 Byte EIS11 / DPT 12.001	C, W, T
2	Switching 3, multiple actuation (1 Bit)	1 Bit EIS1 / DPT 1.001	C, W, T
2	Switching 3, multiple actuation (1 Byte 0..100 %)	1 Byte EIS6 / DPT 5.001	C, W, T
2	Switching 3, multiple actuation (1 Byte 0..255)	1 Byte EIS14 / DPT 5.010	C, W, T
2	Switching 3, multiple actuation (2 Byte Float)	2 Byte EIS5 / DPT 9.xxx	C, W, T
2	Switching 3, multiple actuation (2 Byte Signed)	2 Byte EIS10 / DPT 8.001	C, W, T
2	Switching 3, multiple actuation (2 Byte Unsigned)	2 Byte EIS10 / DPT 7.001	C, W, T
2	Switching 3, multiple actuation (4 Byte Float)	4 Byte EIS9 / DPT 14.xxx	C, W, T
2	Switching 3, multiple actuation (4 Byte Signed)	4 Byte EIS11 / DPT 13.001	C, W, T
2	Switching 3, multiple actuation (4 Byte Unsigned)	4 Byte EIS11 / DPT 12.001	C, W, T
3	Switching 4, multiple actuation (1 Bit)	1 Bit EIS1 / DPT 1.001	C, W, T
3	Switching 4, multiple actuation (1 Byte 0..100 %)	1 Byte EIS6 / DPT 5.001	C, W, T
3	Switching 4, multiple actuation (1 Byte 0..255)	1 Byte EIS14 / DPT 5.010	C, W, T
3	Switching 4, multiple actuation (2 Byte Float)	2 Byte EIS5 / DPT 9.xxx	C, W, T
3	Switching 4, multiple actuation (2 Byte Signed)	2 Byte EIS10 / DPT 8.001	C, W, T
3	Switching 4, multiple actuation (2 Byte Unsigned)	2 Byte EIS10 / DPT 7.001	C, W, T
3	Switching 4, multiple actuation (4 Byte Float)	4 Byte EIS9 / DPT 14.xxx	C, W, T
3	Switching 4, multiple actuation (4 Byte Signed)	4 Byte EIS11 / DPT 13.001	C, W, T
3	Switching 4, multiple actuation (4 Byte Unsigned)	4 Byte EIS11 / DPT 12.001	C, W, T

Multiple actuation objects, rocker left/right, continued

No.	Object name	Data type	Flags
4	Switching 5, multiple actuation (1 Bit)	1 Bit EIS1 / DPT 1.001	C, W, T
4	Switching 5, multiple actuation (1 Byte 0..100 %)	1 Byte EIS6 / DPT 5.001	C, W, T
4	Switching 5, multiple actuation (1 Byte 0..255)	1 Byte EIS14 / DPT 5.010	C, W, T
4	Switching 5, multiple actuation (2 Byte Float)	2 Byte EIS5 / DPT 9.xxx	C, W, T
4	Switching 5, multiple actuation (2 Byte Signed)	2 Byte EIS10 / DPT 8.001	C, W, T
4	Switching 5, multiple actuation (2 Byte Unsigned)	2 Byte EIS10 / DPT 7.001	C, W, T
4	Switching 5, multiple actuation (4 Byte Float)	4 Byte EIS9 / DPT 14.xxx	C, W, T
4	Switching 5, multiple actuation (4 Byte Signed)	4 Byte EIS11 / DPT 13.001	C, W, T
4	Switching 5, multiple actuation (4 Byte Unsigned)	4 Byte EIS11 / DPT 12.001	C, W, T

10.17 Delay

Telegrams can be received via the "Input" object using the "Delay" application. The telegrams received are sent out on the "Output" object with a set delay time.

The object types for "Input" and "Output" can be collectively parameterised for different applications.

Delay objects

No.	Object name	Data type	Flags
0	Input (1 Bit)	1 Bit EIS1 / DPT 1.001	C, W
0	Input (1 Bit)	1 Bit EIS7 / DPT 1.008	C, W
0	Input (1 Bit)	1 Bit EIS7 / DPT 1.007	C, W
0	Input (1 Byte 0..100 %)	1 Byte EIS6 / DPT 5.001	C, W
0	Input (1 Byte 0..255)	1 Byte EIS14 / DPT 5.010	C, W
0	Input (2 Byte Float)	2 Byte EIS5 / DPT 9.xxx	C, W
0	Input (2 Byte Signed)	2 Byte EIS10 / DPT 8.001	C, W
0	Input (2 Byte Unsigned)	2 Byte EIS10 / DPT 7.001	C, W
0	Input (4 Byte Float)	4 Byte EIS9 / DPT 14.xxx	C, W
0	Input (4 Byte Signed)	4 Byte EIS11 / DPT 13.001	C, W
0	Input (4 Byte Unsigned)	4 Byte EIS11 / DPT 12.001	C, W
1	Output (1 Bit)	1 Bit EIS1 / DPT 1.001	C, T
1	Output (1 Bit)	1 Bit EIS7 / DPT 1.008	C, T
1	Output (1 Bit)	1 Bit EIS7 / DPT 1.007	C, T
1	Output (1 Byte 0..100 %)	1 Byte EIS6 / DPT 5.001	C, T
1	Output (1 Byte 0..255)	1 Byte EIS14 / DPT 5.010	C, T
1	Output (2 Byte Float)	2 Byte EIS5 / DPT 9.xxx	C, T
1	Output (2 Byte Signed)	2 Byte EIS10 / DPT 7.001	C, T
1	Output (2 Byte Unsigned)	2 Byte EIS10 / DPT 7.001	C, T
1	Output (4 Byte Float)	4 Byte EIS9 / DPT 14.xxx	C, T
1	Output (4 Byte Signed)	4 Byte EIS11 / DPT 13.001	C, T
1	Output (4 Byte Unsigned)	4 Byte EIS11 / DPT 12.001	C, T
2	Delay time (2 Byte)	2 Byte EIS10 / DPT 7.001	C, R, W

10.18 Staircase lighting

With the "Staircase lighting" application, switching telegrams or value telegrams can be provided with a light-on time. Depending on the parameterisation, the application shows different communication objects:

- a 1-bit object for input and output

If an ON telegram is received via the "Input/Output" object, the light-on time is started immediately. This can be a light-on time of 00:10 min to 88:45 min, which is adjustable in 0.1 s steps. After expiration of the light-on time, the "Input/Output" object sends an OFF telegram.

- two 1-bit objects for input and output

- and two 1-byte objects for input and output

If a telegram is received via the "Input" object, the light-on time is started immediately and a telegram with the same value of the telegram received on the input is sent out on the "Output" object. This can be a light-on time of 00:10 min to 88:45 min, which is adjustable in 0.1 s steps. After expiration of the light-on time, the "Output" object sends out an OFF telegram (1-bit) or a telegram with the value "0" (1-byte).

Via two additional communication objects, it is possible to specify the light-on time and the switch-off prewarning time. The 2-byte values received are written to the memory of the device and are retained even after a bus power failure and subsequent return of voltage.

Staircase lighting objects

No.	Object name	Data type	Flags
0	Input (1 Bit)	1 Bit EIS1 / DPT 1.001	C, W
0	Input (1 Byte)	1 Bit EIS14 / DPT 5.010	C, W
0	Input_Output (1 Bit)	1 Bit EIS1 / DPT 1.001	C, W, T
1	Light-on time (2 Byte)	2 Byte EIS10 / DPT 7.001	C, R, W
2	Switch-off pre-warning	2 Byte EIS10 / DPT 7.001	C, R, W
3	Output (1 Bit)	1 Bit EIS1 / DPT 1.001	C, T
3	Output (1 Byte)	1 Bit EIS14 / DPT 5.010	C, T

10.19 Light scene actuator

With the "Light scene actuator" application, it is possible to call up scenes that are stored in the device via the receipt of a scene number on the 1-byte communication object "Scene call-up". A maximum of eight scenes with up to eight actuator objects can be created.

For triggering different actuators, the size of the actuator groups communication objects can be set under the "Actuator group type" parameter.

The user has the option of saving the scenes himself. A corresponding save telegram must be received for this (see the description of the individual parameters).

Light scene actuator objects

No.	Object name	Data type	Flags
0	Light scene call-up (1 Byte)	1 Byte / DPT18.001	C, W, U
1...10	Actuator group A [B...J] (1-bit switching)	1 Bit EIS1 / DPT 1.001	C, W, T, U
1...10	Actuator group A [B...J] (1-bit Venetian blind)	1 Bit EIS7 / DPT 1.008	C, W, T, U
1...10	Actuator group A [B...J] (1 Byte 0..100 %)	1 Byte EIS6 / DPT 5.001	C, W, T, U
1...10	Actuator group A [B...J] (1-byte light scene number)	1 Byte / DPT 18.001	C, W, T, U
1...10	Actuator group A [B...J] (Temperature value absolute)	2 Byte EIS5 / DPT 9.001	C, W, T, U
10...19	Enable scene 1 [Scene 2 ... Scene 10]	1 Bit EIS1 / DPT 1.001	C, W, T

10.20 Sequence

With the "Sequence" application it is possible to send out multiple telegrams with different values in a predefined sequence consecutively over the same object.

In contrast to the scene, the "Sequence" application has only one communication object on which up to twelve individual values are consecutively sent in twelve firmly set times. The times can be freely set from 1 s to 12 h. The "Sequence" application lends itself to controlling showrooms for example.

The function can be temporarily blocked via an enable object.

Sequence objects

No.	Object name	Data type	Flags
0	Sequence value (1-bit switching)	1 Bit EIS1 / DPT 1.001	C, W, T, U
0	Sequence value (1 Byte 0..100 %)	1 Byte EIS6 / DPT 5.001	C, W, T, U
0	Sequence value (1 Byte 0..255)	1 Byte EIS14 / DPT 5.010	C, W, T, U
0	Sequence value (1-byte light scene number)	1 Byte / DPT 18.001	C, W, T, U
0	Sequence value (2 Byte Float)	2 Byte EIS5 / DPT 9.xxx	C, W, T, U
0	Sequence value (2 Byte Unsigned)	2 Byte EIS10 / DPT 7.001	C, W, T, U
1	Sequence start	1 Bit EIS1 / DPT 1.001	C, W
2	Sequence status	1 Bit EIS1 / DPT 1.001	C, T
4	Enable	1 Bit EIS1 / DPT 1.001	C, W

10.21 Cyclic telegram

Via the "Cyclic telegram" application and after receipt of a telegram on the "Input" object, a telegram with the same volume is cyclically sent out on the "Cyclic output" object.

The object types for "Input" and "Output" can be collectively parameterised for the different applications.

The times for cyclic sending on the "Output" object are adjustable.

Via an additional "Enable" object, there is the option of temporarily blocking the function.

Cyclic telegram objects

No.	Object name	Data type	Flags
0	Input (1-bit switching)	1 Bit EIS1 / DPT 1.001	C, W
0	Input (1-bit alarm)	1 Bit EIS1 / DPT 1.001	C, W
0	Input (1 Byte 0..100 %)	1 Byte EIS6 / DPT 5.001	C, W
0	Input (1 Byte 0..255)	1 Byte EIS14 / DPT 5.010	C, W
0	Input (2 Byte Float)	2 Byte EIS5 / DPT 9.xxx	C, W
0	Input (2 Byte Signed)	2 Byte EIS10 / DPT 8.001	C, W
0	Input (2 Byte Unsigned)	2 Byte EIS10 / DPT 7.001	C, W
0	Input (2-byte temperature)	2 Byte EIS5 / DPT 9.001	C, W
0	Input (4 Byte Float)	4 Byte EIS9 / DPT 14.xxx	C, W
0	Input (4 Byte Signed)	4 Byte EIS11 / DPT 13.001	C, W
0	Input (4 Byte Unsigned)	4 Byte EIS11 / DPT 12.001	C, W
1	Output (1-bit switching)	1 Bit EIS1 / DPT 1.001	C, T
1	Output (1-bit alarm)	1 Bit EIS1 / DPT 1.001	C, T
1	Output (1 Byte 0..100 %)	1 Byte EIS6 / DPT 5.001	C, T
1	Output (1 Byte 0..255)	1 Byte EIS14 / DPT 5.010	C, T
1	Output (2 Byte Float)	2 Byte EIS5 / DPT 9.xxx	C, T
1	Output (2 Byte Signed)	2 Byte EIS10 / DPT 8.001	C, T
1	Output (2 Byte Unsigned)	2 Byte EIS10 / DPT 7.001	C, T
1	Output (2-byte temperature)	2 Byte EIS5 / DPT 9.001	C, T
1	Output (4 Byte Float)	4 Byte EIS9 / DPT 14.xxx	C, T
1	Output (4 Byte Signed)	4 Byte EIS11 / DPT 13.001	C, T
1	Output (4 Byte Unsigned)	4 Byte EIS11 / DPT 12.001	C, T
2	Enable	1 Bit EIS1 / DPT 1.001	C, W

10.22 Flashing

In order to trigger a flashing sequence on the output object, a telegram must be received on the input object beforehand.

The "Flashing" parameter specifies whether the flashing sequence is started with an ON or an OFF telegram on the input object. Alternatively, the flashing sequence can be also be started with a "Change of state", i.e. if the input signal switches from "0" to "1" or from "1" to "0".

Flashing objects

No.	Object name	Data type	Flags
0	Input	1 Bit EIS1 / DPT 1.001	C, W
1	Output	1 Bit EIS1 / DPT 1.001	C, T

10.23 Logic

Logic objects

No.	Object name	Data type	Flags
0	Output (1 Bit)	1 Bit EIS1 / DPT 1.001	C, W, T
0	Output (1 Byte)	1 Byte EIS14 / DPT 5.010	C, W, T
1	Input 1 (1 Bit)	1 Bit EIS1 / DPT 1.001	C, W, U
1	Input 1 (1 Byte)	1 Byte EIS14 / DPT 5.010	C, W, U
2	Input 2 (1 Bit)	1 Bit EIS1 / DPT 1.001	C, W, U
2	Input 2 (1 Byte)	1 Byte EIS14 / DPT 5.010	C, W, U
3	Input 3 (1 Bit)	1 Bit EIS1 / DPT 1.001	C, W, U
3	Input 3 (1 Byte)	1 Byte EIS14 / DPT 5.010	C, W, U
4	Input 4 (1 Bit)	1 Bit EIS1 / DPT 1.001	C, W, U
4	Input 4 (1 Byte)	1 Byte EIS14 / DPT 5.010	C, W, U
5	Input 5 (1 Bit)	1 Bit EIS1 / DPT 1.001	C, W, U
5	Input 5 (1 Byte)	1 Byte EIS14 / DPT 5.010	C, W, U
6	Input 6 (1 Bit)	1 Bit EIS1 / DPT 1.001	C, W, U
6	Input 6 (1 Byte)	1 Byte EIS14 / DPT 5.010	C, W, U
7	Input 7 (1 Bit)	1 Bit EIS1 / DPT 1.001	C, W, U
7	Input 7 (1 Byte)	1 Byte EIS14 / DPT 5.010	C, W, U
8	Input 8 (1 Bit)	1 Bit EIS1 / DPT 1.001	C, W, U
8	Input 8 (1 Byte)	1 Byte EIS14 / DPT 5.010	C, W, U
9	Input 9 (1 Bit)	1 Bit EIS1 / DPT 1.001	C, W, U
9	Input 9 (1 Byte)	1 Byte EIS14 / DPT 5.010	C, W, U
10	Input 10 (1 Bit)	1 Bit EIS1 / DPT 1.001	C, W, U
10	Input 10 (1 Byte)	1 Byte EIS14 / DPT 5.010	C, W, U

10.24 Gate

The "Gate" application allows specific signals to be filtered and the signal flow to be temporarily blocked. The function has three communication objects: "Control input", "Input" and "Output".

The input or output object can assume different sizes.

The bit size can be freely assigned with the "Not assigned" setting. This means that the first internal or external group address/action that is assigned and already connected to some other communication object will specify the size.

The control can occur from "Input to output" or also from "Output to input", provided the control input allows this. Enabling via the control input can occur via an ON or an OFF telegram.

If, for example, the "Control input" setting is set to "ON telegram", only telegrams from the input are transmitted to the output, if prior to this the control input has received an ON telegram.

It is also possible to block signals via the "Filter function" setting. Either "nothing is filtered out" or the signal "ON is filtered out" or the signal "OFF is filtered out". This function is always necessary, for example, when only the ON telegram is interesting for a sensor and the sensor does not offer any filter function in its application program.

Gate objects

No.	Object name	Data type	Flags
0	Input	-	C, W, T
1	Output	-	C, W, T
2	Control input	1 Bit EIS1 / DPT 1.001	C, W

10.25 Min/Max value transducer

Up to eight input values can be compared with each other using the "Min/max value transducer" application. The application can output the highest input value, the smallest input value or the average of all input values on the output.

The size of the input objects, and with it also the size of the output object can be adapted for the most diverse applications.

You can select from the following object types:

- 1-byte 0..100 %, for comparison of percent values
- 1-byte 0..255, for the comparison of decimal values between 0 and 255
- 2-byte float, for the comparison of 2-byte floating point values (physical values such as temperature, brightness value etc.)
- 2-byte signed, for the comparison of decimal values between -32,768 and +32,767
- 2-byte unsigned, for the comparison of decimal values between 0 and 65,535
- 4-byte float, for the comparison of 4-byte floating point values (physical values such as acceleration, electrical current, work etc.)
- 4-byte signed, for the comparison of decimal values between -2,147,483,648 and 2,147,483,647
- 4-byte unsigned, for the comparison of decimal values between 0 and 4,294,967,295

Hint:

With whole numbers the average value is rounded.

Min/Max value transducer objects

No.	Object name	Data type	Flags
0	Output (1 Byte 0..100 %)	1 Byte EIS6 / DPT 5.001	C, T
0	Output (1 Byte 0..255)	1 Byte EIS14 / DPT 5.010	C, T
0	Output (2 Byte Float)	2 Byte EIS5 / DPT 9.xxx	C, T
0	Output (2 Byte Signed)	2 Byte EIS10 / DPT 8.001	C, T
0	Output (2 Byte Unsigned)	2 Byte EIS10 / DPT 7.001	C, T
0	Output (4 Byte Float)	4 Byte EIS9 / DPT 14.xxx	C, T
0	Output (4 Byte Signed)	4 Byte EIS11 / DPT 13.001	C, T
0	Output (4 Byte Unsigned)	4 Byte EIS11 / DPT 12.001	C, T
1...10	Input 1 [2...10] (1 Byte 0..100 %)	1 Byte EIS6 / DPT 5.001	C, W
1...10	Input 1 [2...10] (1 Byte 0..255)	1 Byte EIS14 / DPT 5.010	C, W
1...10	Input 1 [2...10] (2 Byte Float)	2 Byte EIS5 / DPT 9.xxx	C, W
1...10	Input 1 [2...10] (2 Byte Signed)	2 Byte EIS10 / DPT 8.001	C, W
1...10	Input 1 (2 Byte Unsigned)	2 Byte EIS10 / DPT 7.001	C, W
1...10	Input 1 [2...10] (4 Byte Float)	4 Byte EIS9 / DPT 14.xxx	C, W
1...10	Input 1 [2...10] (4 Byte Signed)	4 Byte EIS11 / DPT 13.001	C, W
1...10	Input 1 [2...10] (4 Byte Unsigned)	4 Byte EIS11 / DPT 12.001	C, W

10.26 Threshold value / hysteresis

With the "Threshold value / Hysteresis" application, value telegrams can be received on an input communication object and compared with threshold values specified in the device.

Predefined values are sent out on the communication "Output" communication object if the upper or lower thresholds are exceeded. The size of the object can be adjusted for different applications.

The function can be temporarily blocked via an enable object.

If the value of the lower threshold lies above the value for the upper threshold, the function is not executed.

Threshold value / hysteresis objects

No.	Object name	Data type	Flags
0	Input (1 Byte 0..100 %)	1 Byte EIS6 / DPT 5.001	C, W
0	Input (1 Byte 0..255)	1 Byte EIS14 / DPT 5.010	C, W
0	Input (2 Byte Float)	2 Byte EIS5 / DPT 9.xxx	C, W
0	Input (2 Byte Signed)	2 Byte EIS10 / DPT 8.001	C, W
0	Input (2 Byte Unsigned)	2 Byte EIS10 / DPT 7.001	C, W
0	Input (4 Byte Float)	4 Byte EIS9 / DPT 14.xxx	C, W
0	Input (4 Byte Signed)	4 Byte EIS11 / DPT 12.001	C, W
0	Input (4 Byte Unsigned)	4 Byte EIS11 / DPT 13.001	C, W
1	Output (1 Bit)	1 Bit EIS1 / DPT 1.001	C, T
1	Output (1 Byte 0..100 %)	1 Byte EIS6 / DPT 5.001	C, T
1	Output (1 Byte 0..255)	1 Byte EIS14 / DPT 5.010	C, T
2	Enable	1 Bit EIS1 / DPT 1.001	C, W

10.27 Priority

The "Priority" application has 3 communication objects, a 1-bit object "Switch input", a 2-bit object "Input priority" and a 1-bit object "Output". The telegrams received on the "Switch input" are transferred to the "Output" depending on the state of the "Input priority" object.

The 2-bit object "Input priority" can receive and differentiate between four different values (0, 1, 2 and 3). Here, the "Output" object is positively driven. Three different states are differentiated:

- "Input priority" has value "3": the value that is present on "Switch input" has no meaning. The "Output" is switched to positively driven and has the value "1".
- "Input priority" has the value "2". The value that is present on "Switch input" has no meaning. The "Output" is switched off positively driven and has the value "0".
- "Input priority" has the value "1" or "0". The "Output" is not positively driven. The "Switch input" is linked to the status bit of the priority object OR and transferred to the "Output".

During a positive drive, changes of the "Switch input" object are saved, even if the current state on the "Output" object does not immediately change through this. If the positive drive is terminated, a telegram transmission on the "Output" occurs according to the current value of the "Switch input" object.

Priority objects

No.	Object name	Data type	Flags
0	Switch input	1 Bit EIS1 / DPT 1.001	C, W
1	Priority input	2 Bit EIS8 / DPT 2.001	C, W
2	Output	1 Bit EIS1 / DPT 1.001	C, T

Contact us

A member of the ABB Group

Busch-Jaeger Elektro GmbH

PO box

58505 Lüdenscheid

Freisenbergstraße 2

58513 Lüdenscheid

Germany

www.BUSCH-JAEGER.com

info.bje@de.abb.com

Central sales service:

Phone: +49 180 5 669900

Fax: +49 180 5 669909

Notice

We reserve the right to at all times make technical changes as well as changes to the contents of this document without prior notice.

The detailed specifications agreed to at the time of ordering apply to all orders. ABB accepts no responsibility for possible errors or incompleteness in this document.

We reserve all rights to this document and the topics and illustrations contained therein. The document and its contents, or extracts thereof, must not be reproduced, transmitted or reused by third parties without prior written consent by ABB.

Copyright© 2011 Busch-Jaeger Elektro GmbH
All rights reserved

0073-1-7704 | Rev. 01 | 04.2011